

Date: _____	Job: _____	Type: _____
Notes: _____		Quantity: _____



The IG2 two inch in-ground LED lights are solidly constructed of corrosion resistant brass and 316L stainless steel. They will withstand the most challenging environments. The IG2 fixtures are rated for drive-over applications, as well as having an impact resistance of IK10. These in-ground lights are perfect for interior and exterior in-ground and step/wall lighting applications.

IP67
IK10



Technical Specifications:

Operating Voltage	12VAC/DC
Power Consumption	2.5W
Lumens Delivered (3000K open trim)	137lm
Efficacy (3000K)	69lm/W
IES Files (3000K)	
LED Chips	SMD
Color Temperatures	CCT Selectable: 2700K, 3000K, 4000K
CRI	90+
MacAdam Ellipse Binning	3-step
Beam	19°, 36°, 60°
Dimmable	YES
Housing	Solid brass
Trims	Solid brass / 316L stainless steel
IP Rating	67
Impact Rating	IK10
Drive-over Rated	YES
Warranty	5 years

Dimensions:

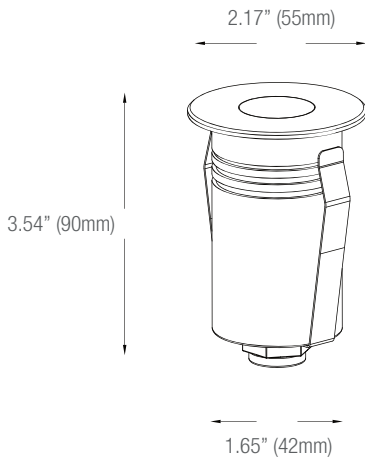

Comes with 12" lead

Installation:



1 1/2" Schedule 80 PVC for concrete pour applications.



IGC - In-ground Cylinder

Trims:



RD - Round*
Ø2.17"

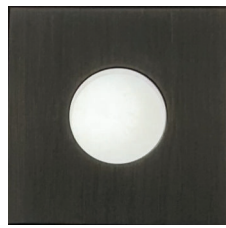

SQ - Square*
2.17 x 2.17"

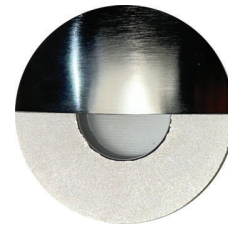

WW - Wall Wash*
Ø2.17"

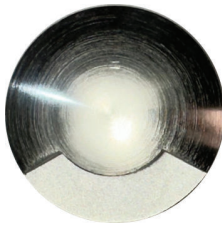

1W - 1-Way
Ø2.17"



2W - 2-Way
Ø2.17"

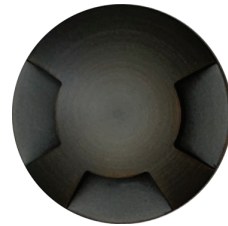

3W - 3-Way
Ø2.17"

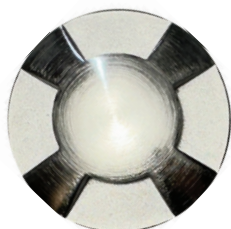

4W - 4-Way
Ø2.17"



HL - Halo
Ø2.17"



SE - Side Emitting
Ø2.17"

*All Round, Square, and Wall Wash trims come with 19°, 36°, and 60° lenses, as well as honey comb filter, diffusion and linear spread lenses.

Ordering Code:

IG2 - 123 - -





TRIM

- RD - Round
- SQ - Square
- WW - Wall Wash
- HL - Halo
- SE - Side-Emitting
- 1W - 1-Way
- 2W - 2-Way
- 3W - 3-Way
- 4W - 4-Way

FINISH

- BR - Brass
- AB - Antique Brass
- SS - Stainless Steel

Driver Cutsheets:

DESCRIPTION	INPUT	OUTPUT	WATTAGES	SPECIFICATION SHEETS
Non-Dimming Indoor	120VAC	12VDC	15W, 30W	DR-12VDC 
Non-Dimming Indoor/Outdoor	120VAC	12VDC	30W-264W	DR-12VDC-OUT 
Universal Phase Dimming Indoor	120VAC	12VDC	24W 48W 60W	DR-12VDC-DIMA 
Univ. Phase/0-10V Dimming Ind./Out.	100-277VAC	12VDC	30W-300W	DR-12VDC-DIMS-UNV 

Voltage Drop Calculator:

Wire Gauge Calculator - Load vs AWG vs Max. Distance Away From Driver

LOAD	10W	20W	30W	40W	50W	60W
WIRE GAUGE						
20AWG	18 ft	9 ft	6 ft	5 ft	4 ft	3 ft
18AWG	34 ft	17 ft	11 ft	8 ft	6 ft	5 ft
16AWG	54 ft	27 ft	18 ft	13 ft	10 ft	9 ft
14AWG	86 ft	43 ft	29 ft	21 ft	17 ft	14 ft
12AWG	134 ft	68 ft	45 ft	34 ft	27 ft	22 ft
10AWG	199 ft	99 ft	66 ft	49 ft	39 ft	33 ft